

大阪市立科学館単線接続図

- 注 1. 変圧器 (MTR1, 2, TR3~7) は日新納入外
 2. 集計OCGのヨビはスペースのみとユニットは非実装

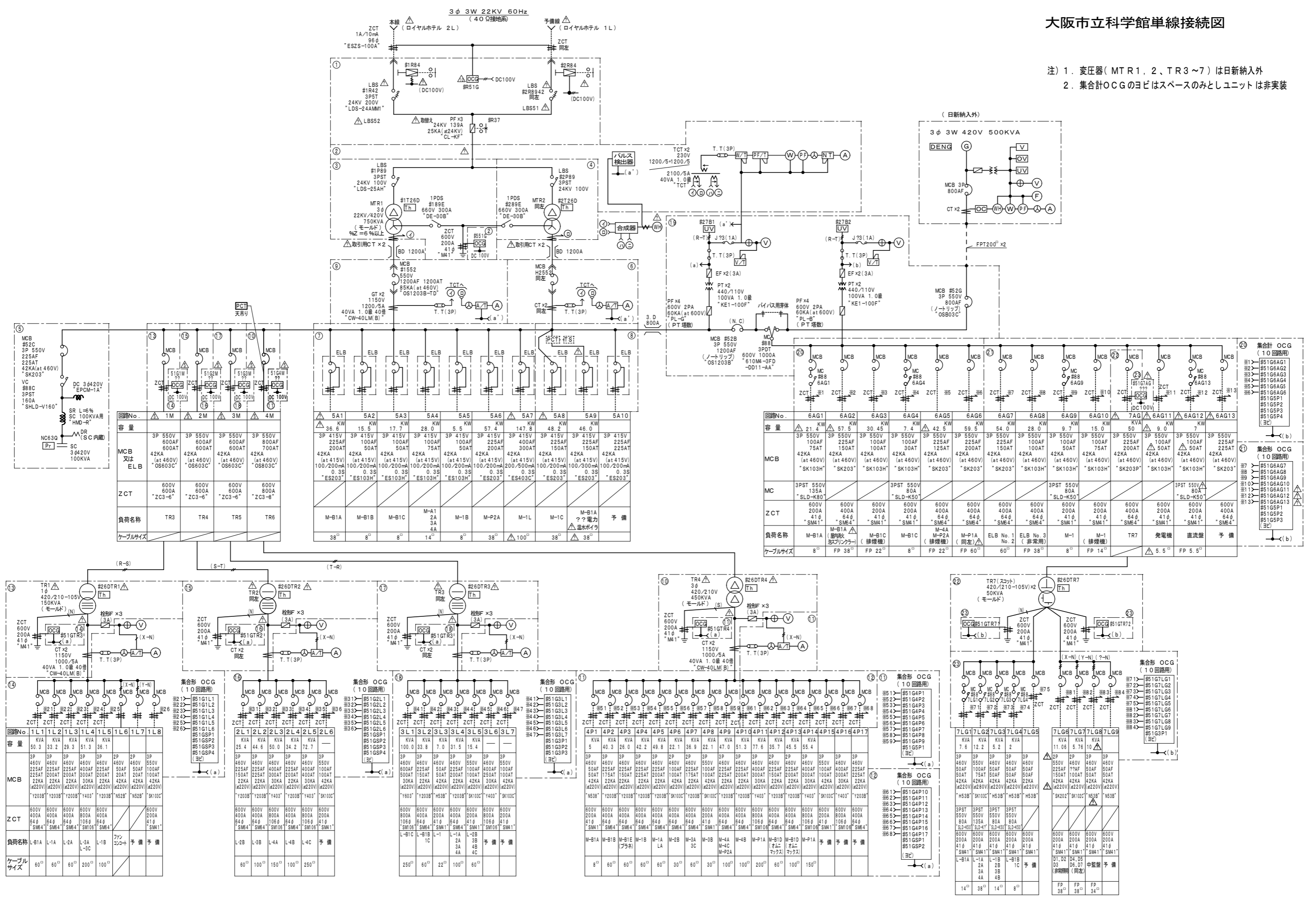

回路No.	1M	2M	3M	4M
容量	3P 550V 600AF 42KA (at 460V) "OS603C"	3P 550V 600AF 42KA (at 460V) "OS603C"	3P 550V 600AF 42KA (at 460V) "OS603C"	3P 550V 700AF 42KA (at 460V) "OS803C"
ZCT	600V 200A "ZC3-6"	600V 200A "ZC3-6"	600V 200A "ZC3-6"	600V 200A "ZC3-6"
負荷名称	TR3	TR4	TR5	TR6
ケーブルサイズ				

回路No.	5A1	5A2	5A3	5A4	5A5	5A6	5A7	5A8	5A9	5A10	
容量	3P 415V 225AF 42KA (at 415V) 100/200mA 0.3S "ES203"	3P 415V 225AF 42KA (at 415V) 100/200mA 0.3S "ES103H"	3P 415V 225AF 42KA (at 415V) 100/200mA 0.3S "ES103H"	3P 415V 225AF 42KA (at 415V) 100/200mA 0.3S "ES103H"	3P 415V 225AF 42KA (at 415V) 100/200mA 0.3S "ES103H"	3P 415V 225AF 42KA (at 415V) 100/200mA 0.3S "ES203"	3P 415V 225AF 42KA (at 415V) 100/200mA 0.3S "ES403C"	3P 415V 225AF 42KA (at 415V) 100/200mA 0.3S "ES203"	3P 415V 225AF 42KA (at 415V) 100/200mA 0.3S "ES203"	3P 415V 225AF 42KA (at 415V) 100/200mA 0.3S "ES203"	3P 415V 225AF 42KA (at 415V) 100/200mA 0.3S "ES203"
ZCT											
負荷名称	M-B1A	M-B1B	M-B1C	M-A1 2A 3A 4A	M-1B	M-P2A	M-1L	M-1C	M-B1A ??電力	予備	
ケーブルサイズ	38 [□]	8 [□]	8 [□]	14 [□]	8 [□]	38 [□]	100 [□]	38 [□]	36 [□]		

回路No.	6AG1	6AG2	6AG3	6AG4	6AG5	6AG6	6AG7	6AG8	6AG9	6AG10	7AG	6AG11	6AG12	6AG13
容量	3P 550V 100AF 42KA (at 460V) "SK103H"	3P 550V 225AF 42KA (at 460V) "SK203"	3P 550V 100AF 42KA (at 460V) "SK103H"	3P 550V 100AF 42KA (at 460V) "SK103H"	3P 550V 100AF 42KA (at 460V) "SK203"	3P 550V 100AF 42KA (at 460V) "SK203"	3P 550V 100AF 42KA (at 460V) "SK203"	3P 550V 100AF 42KA (at 460V) "SK103H"	3P 550V 100AF 42KA (at 460V) "SK103H"	3P 550V 100AF 42KA (at 460V) "SK103H"	3P 550V 100AF 42KA (at 460V) "SK203P"	3P 550V 100AF 42KA (at 460V) "SK103H"	3P 550V 100AF 42KA (at 460V) "SK103H"	3P 550V 100AF 42KA (at 460V) "SK203"
ZCT														
負荷名称	M-B1A	M-B1A ?電機	M-B1C (排煙機)	M-B1C (排煙機)	M-P1A	M-P1A (排煙機)	ELB No. 1 No. 2 (非常用)	M-1 (排煙機)	M-1 (排煙機)	M-1 (排煙機)	TR7	発電機	直流機	予備
ケーブルサイズ	8 [□]	FP 38 [□]	FP 22 [□]	8 [□]	FP 22 [□]	FP 60 [□]	60 [□]	FP 38 [□]	8 [□]	FP 14 [□]	△ 5.5 [□]	FP 5.5 [□]		

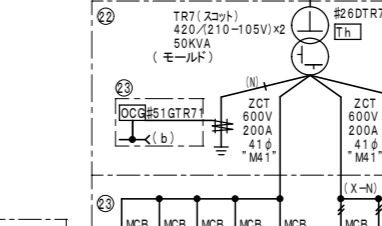
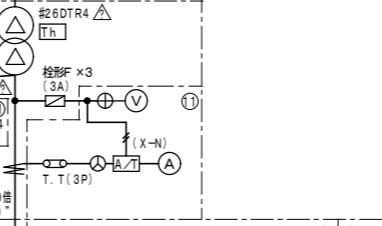
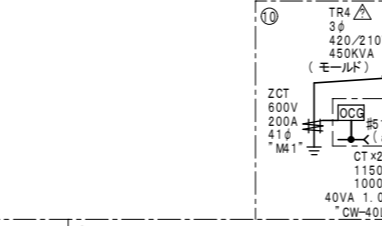
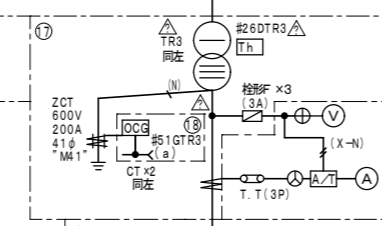
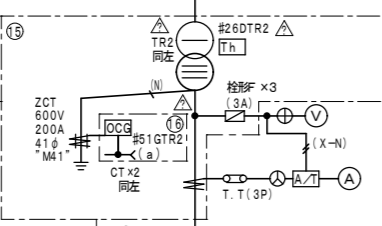
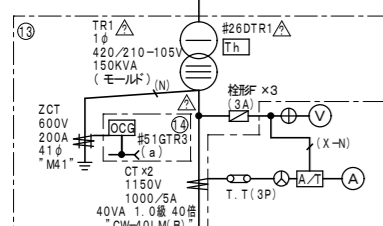

回路No.	1L1	1L2	1L3	1L4	1L5	1L6	1L7	1L8
容量	3P 3P 460V 225AF 42KA (at 460V) "SK103H"	3P 3P 460V 225AF 42KA (at 460V) "SK103H"	3P 3P 460V 225AF 42KA (at 460V) "SK103H"	3P 3P 460V 225AF 42KA (at 460V) "SK103H"	3P 3P 460V 225AF 42KA (at 460V) "SK103H"	3P 3P 460V 225AF 42KA (at 460V) "SK103H"	3P 3P 460V 225AF 42KA (at 460V) "SK103H"	3P 3P 460V 225AF 42KA (at 460V) "SK103H"
ZCT								
負荷名称	L-B1A	L-1A	L-2A	L-3A L-3C	L-1B	ファン コンタ	予備	予備
ケーブルサイズ	60 [□]	60 [□]	60 [□]	200 [□]	100 [□]			

回路No.	2L1	2L2	2L3	2L4	2L5	2L6
容量	3P 3P 460V 225AF 42KA (at 460V) "SK103H"	3P 3P 460V 225AF 42KA (at 460V) "SK103H"	3P 3P 460V 225AF 42KA (at 460V) "SK103H"	3P 3P 460V 225AF 42KA (at 460V) "SK103H"	3P 3P 460V 225AF 42KA (at 460V) "SK103H"	3P 3P 460V 225AF 42KA (at 460V) "SK103H"
ZCT						
負荷名称	L-2B	L-3B	L-4A	L-4B	L-4C	予備
ケーブルサイズ	60 [□]	100 [□]	150 [□]	100 [□]	250 [□]	

回路No.	3L1	3L2	3L3	3L4	3L5	3L6	3L7
容量	3P 3P 460V 225AF 42KA (at 460V) "SK103H"	3P 3P 460V 225AF 42KA (at 460V) "SK103H"	3P 3P 460V 225AF 42KA (at 460V) "SK103H"	3P 3P 460V 225AF 42KA (at 460V) "SK103H"	3P 3P 460V 225AF 42KA (at 460V) "SK103H"	3P 3P 460V 225AF 42KA (at 460V) "SK103H"	3P 3P 460V 225AF 42KA (at 460V) "SK103H"
ZCT							
負荷名称	L-B1C	L-B1B	L-1	L-2B 2A 3A 4A	L-2B 3B 4B 4C	予備	予備
ケーブルサイズ	250 [□]	60 [□]	22 [□]	100 [□]	60 [□]		

回路No.	4P1	4P2	4P3	4P4	4P5	4P6	4P7	4P8	4P9	4P10	4P11	4P12	4P13	4P14	4P15	4P16	4P17
容量	3P 3P 460V 225AF 42KA (at 460V) "SK103H"	3P 3P 460V 225AF 42KA (at 460V) "SK103H"	3P 3P 460V 225AF 42KA (at 460V) "SK103H"	3P 3P 460V 225AF 42KA (at 460V) "SK103H"	3P 3P 460V 225AF 42KA (at 460V) "SK103H"	3P 3P 460V 225AF 42KA (at 460V) "SK103H"	3P 3P 460V 225AF 42KA (at 460V) "SK103H"	3P 3P 460V 225AF 42KA (at 460V) "SK103H"	3P 3P 460V 225AF 42KA (at 460V) "SK103H"	3P 3P 460V 225AF 42KA (at 460V) "SK103H"	3P 3P 460V 225AF 42KA (at 460V) "SK103H"	3P 3P 460V 225AF 42KA (at 460V) "SK103H"	3P 3P 460V 225AF 42KA (at 460V) "SK103H"	3P 3P 460V 225AF 42KA (at 460V) "SK103H"	3P 3P 460V 225AF 42KA (at 460V) "SK103H"	3P 3P 460V 225AF 42KA (at 460V) "SK103H"	3P 3P 460V 225AF 42KA (at 460V) "SK103H"
ZCT																	
負荷名称	M-B1A	M-B1B	M-B1E (プラネ)	M-1B	M-1A LA	M-2B M-3A	M-3B	M-4A M-2A	M-4B	M-P1A	M-B1D "オニ マカス"	M-B1D "オニ マカス"	M-P1A	予備	予備	予備	予備
ケーブルサイズ	6 [□]	60 [□]	60 [□]	60 [□]	30 [□]	30 [□]	30 [□]	100 [□]	100 [□]	200 [□]	60 [□]	100 [□]	150 [□]				

回路No.	7L1	7L2	7L3	7L4	7L5
容量	3P 3P 460V 225AF 42KA (at 460V) "SK103H"	3P 3P 460V 225AF 42KA (at 460V) "SK103H"	3P 3P 460V 225AF 42KA (at 460V) "SK103H"	3P 3P 460V 225AF 42KA (at 460V) "SK103H"	3P 3P 460V 225AF 42KA (at 460V) "SK103H"
ZCT					
負荷名称	L-B1A	L-1A	L-2A	L-1B 1C 予備	予備
ケーブルサイズ	14 [□]	38 [□]	14 [□]	8 [□]	

回路No.	7L6	7L7	7L8	7L9
容量	3P 3P 460V 225AF 42KA (at 460V) "SK103H"	3P 3P 460V 225AF 42KA (at 460V) "SK103H"	3P 3P 460V 225AF 42KA (at 460V) "SK103H"	3P 3P 460V 225AF 42KA (at 460V) "SK103H"
ZCT				
負荷名称	L-B1A	L-1A	L-2A	L-1B 1C 予備
ケーブルサイズ	14 [□]	38 [□]	14 [□]	8 [□]

回路No.	7L10	7L11	7L12	7L13	7L14	7L15
容量	3P 3P 460V 225AF 42KA (at 460V) "SK103H"	3P 3P 460V 225AF 42KA (at 460V) "SK103H"	3P 3P 460V 225AF 42KA (at 460V) "SK103H"	3P 3P 460V 225AF 42KA (at 460V) "SK103H"	3P 3P 460V 225AF 42KA (at 460V) "SK103H"	3P 3P 460V 225AF 42KA (at 460V) "SK103H"
ZCT						
負荷名称	L-B1A	L-1A	L-2A	L-1B 1C 予備	予備	予備
ケーブルサイズ	14 [□]	38 [□]	14 [□]	8 [□]		

- 集計 OCG (10回路用)
 ※1 #51G6A1
 ※2 #51G6A2
 ※3 #51G6A3
 ※4 #51G6A4
 ※5 #51G6A5
 ※6 #51G6A6
 ※7 #51G5P1
 ※8 #51G5P2
 ※9 #51G5P3
 ※10 #51G5P4 (3C)
- 集計 OCG (10回路用)
 ※1 #51G6A7
 ※2 #51G6A8
 ※3 #51G6A9
 ※4 #51G6A10
 ※5 #51G6A11
 ※6 #51G6A12
 ※7 #51G6A13
 ※8 #51G5P1
 ※9 #51G5P2
 ※10 #51G5P3 (3C)